

Indhold

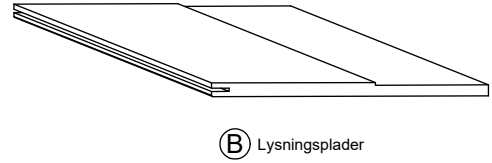

1. Måltagning + opskæring (af lysningsplader)

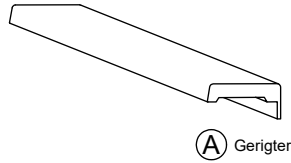
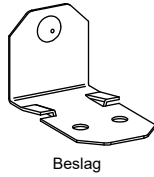
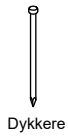
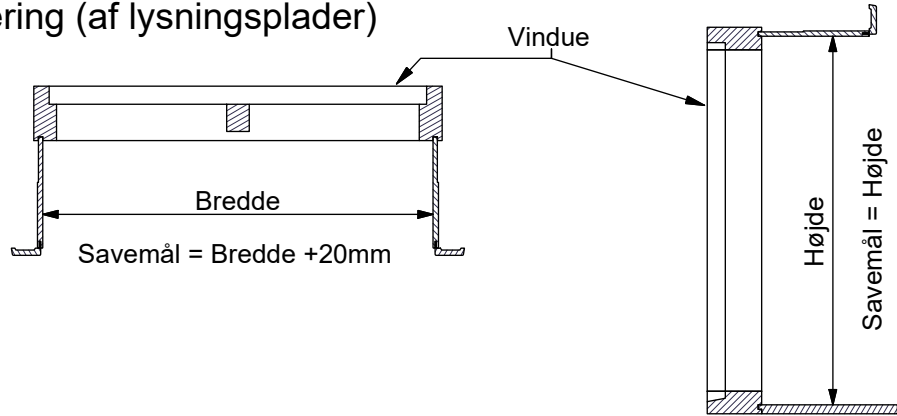
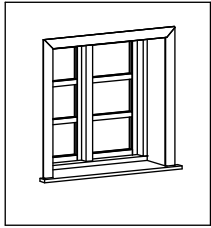

2. Tildanne topløsning

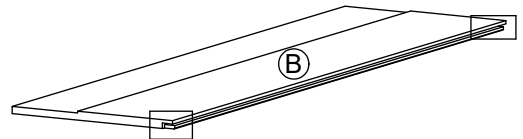
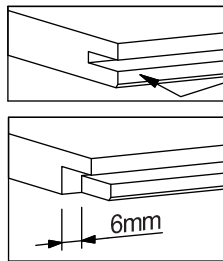
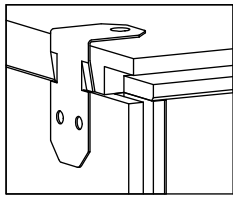

3. Beslag på sider

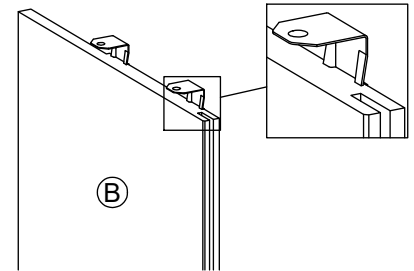
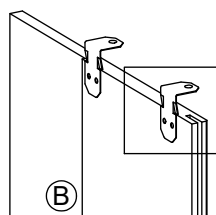
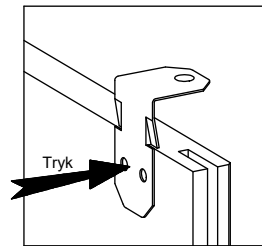
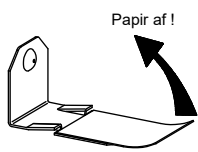

4. Sidelysninger ind

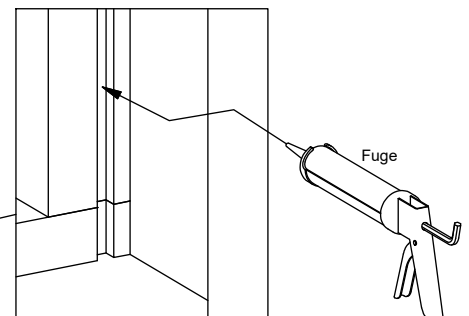
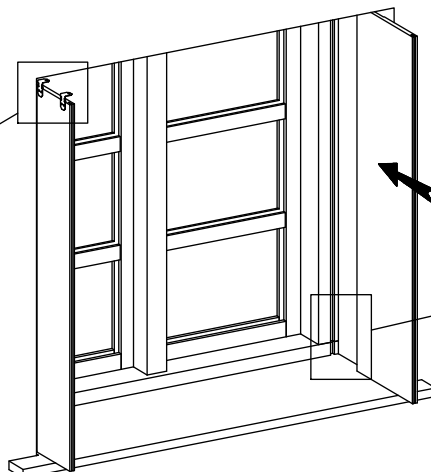
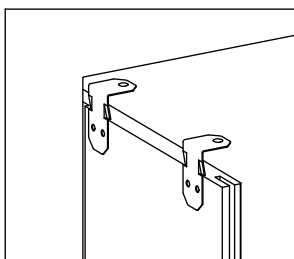

## 5. Toplysning ind

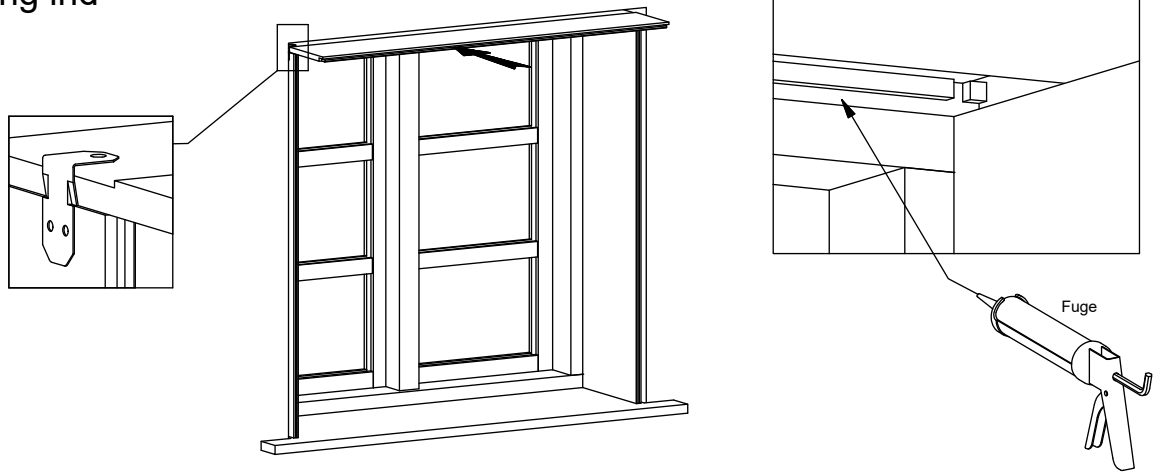

## 6. Save flexgerigter

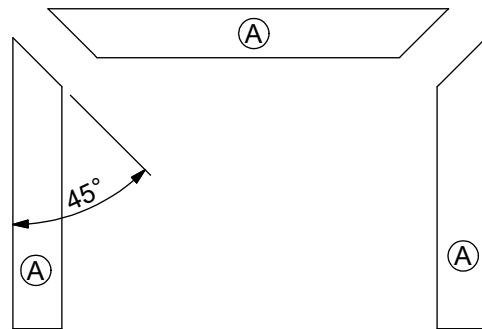
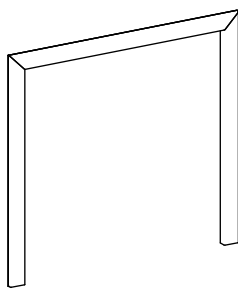

## 7. Flexgerigter ind

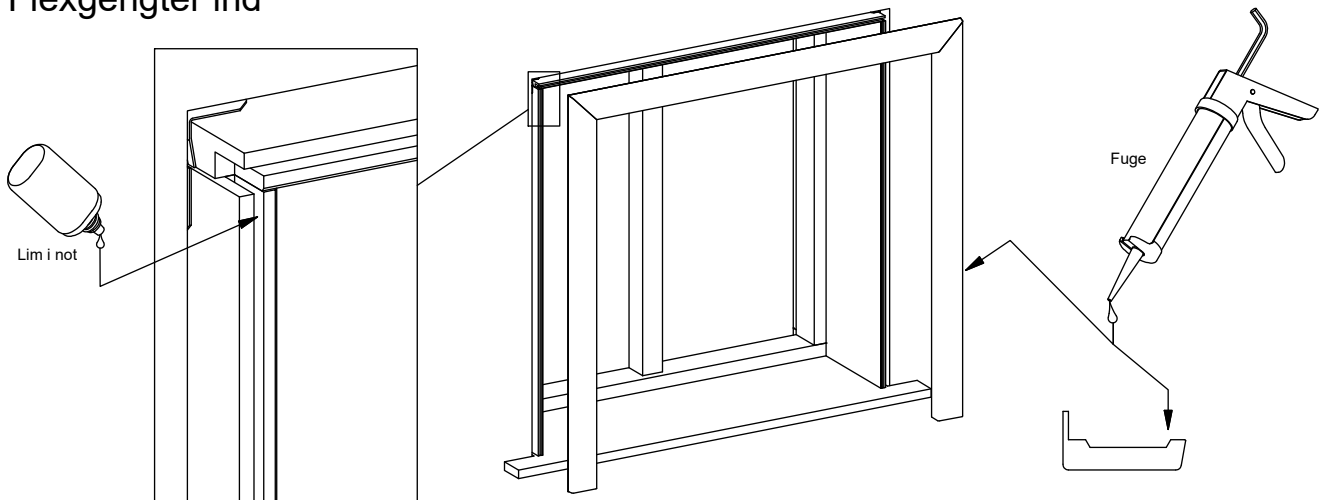

## 8. Montage af gerigter

